

Discover more flexibility & shorter development time with

LEX SMART - Computer on Modules

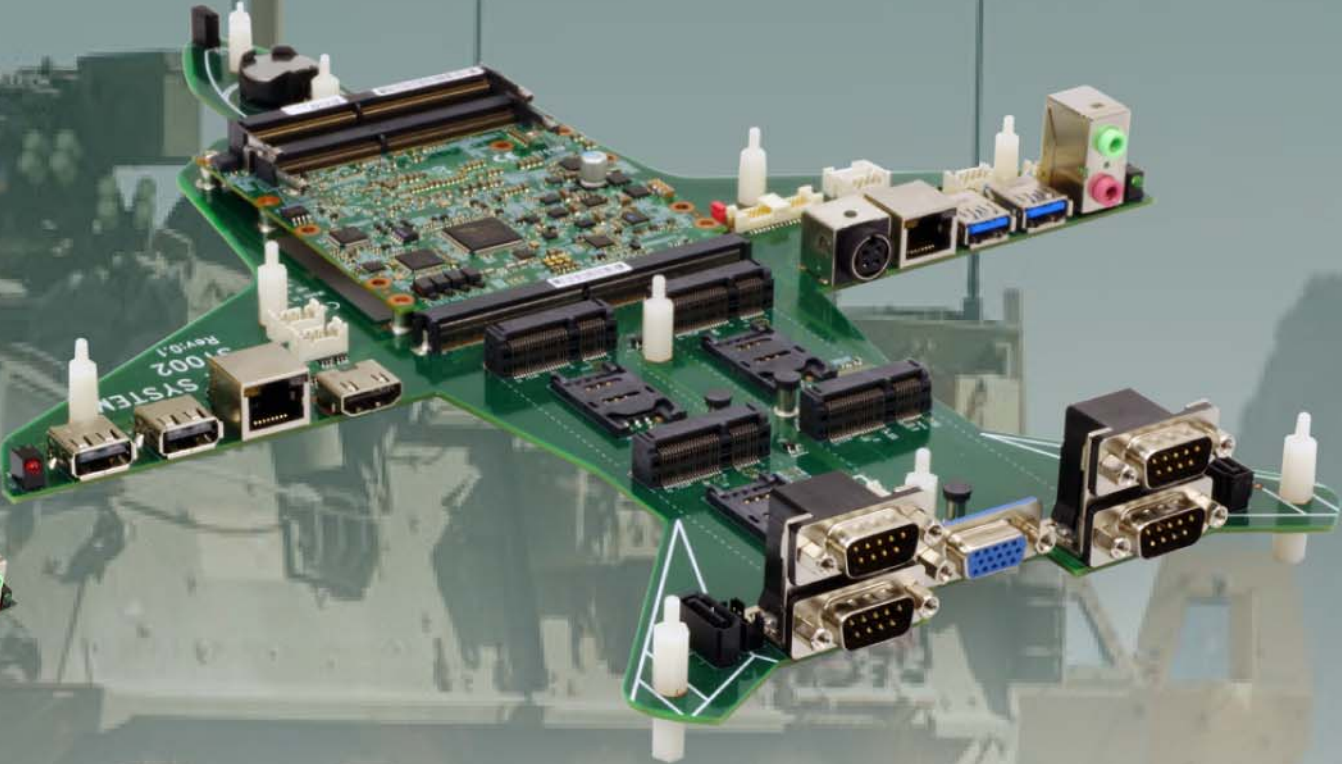

ST610W



ST610W + ST002



ST002





Discover more flexibility & shorter development time with **LEX SMART - Computer on Modules**

LEX launches ST610W Computer on Modules with Intel® Skylake-U / Kaby Lake-U i3/i5/i7, Celeron processor to give users flexible, reliable and cableless solution for configuring the customized system in the shortest time. By connecting with MXM-3 connectors (314-pin expansion), users can adopt a carrier board with suitable I/O interfaces.

With more flexible and complete functions than COM Express® and SMARC 2.0 options, LEX's SMART-ST610W provides customer the maximize potential with their carrier boards to build their own compact, high-performance system designed in a shortened development time. ST610W's design is also the ideal solution for embedded application developers to get up and running quickly on their customized carrier boards for different OEM/ODM projects.



Front



Bottom

LEX SMART

Computer on Modules

More functions than COMe and SMARC 2.0

Save your time and money to develop carrier board

ST610W	
DDR4 SO-DIMM, max up to 32GB	HD Audio with Amplifier
VGA, HDMI, LVDS 24 bit / 2CH	9~36V DC-Input
Resister Touch Screen Controller	5V, 12V DC-Output
2 x Intel GbE i210 LAN	LPC
2 x USB 3.0, 5 x USB 2.0	Watch Dog Timer 0-255 second
4 x COM RS232 / 422 / 485 Auto	Dimension: 110 x 88 mm
4 x PCIe	Operation Temp.: -20°C~70°C
2 x SATA	Operation Humidity: 5~95%, non-condensing
8 x DI / 8 x DO	



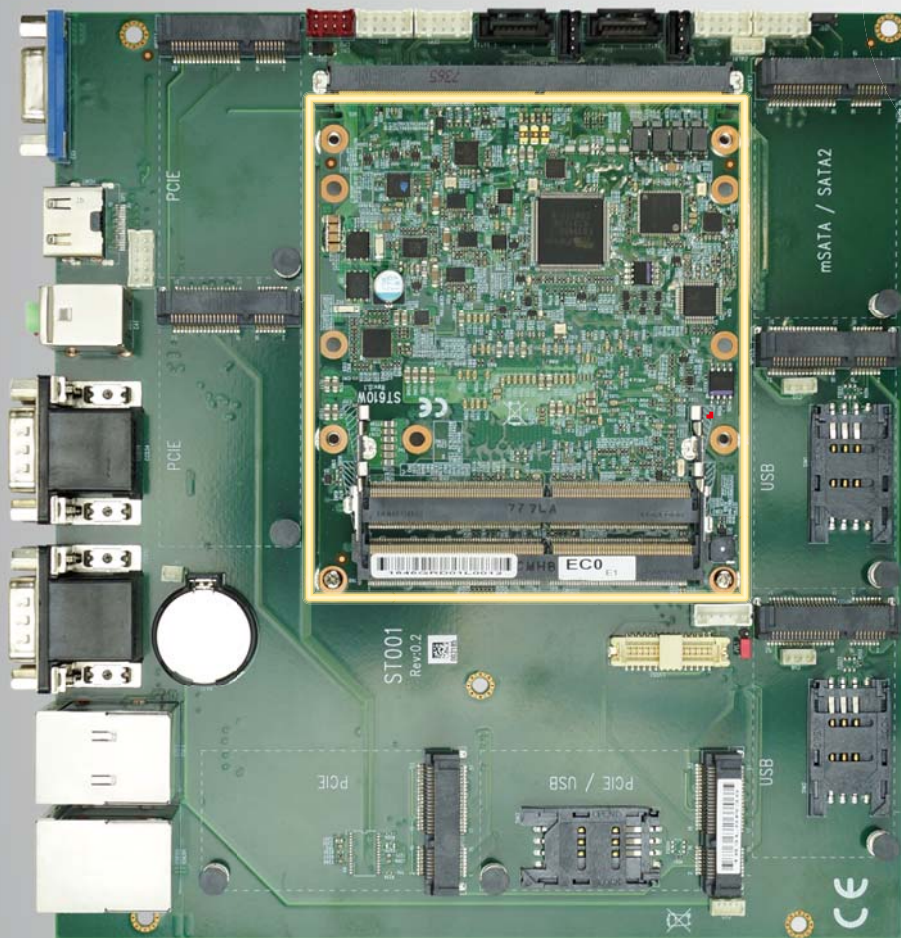

ST610W + ST001

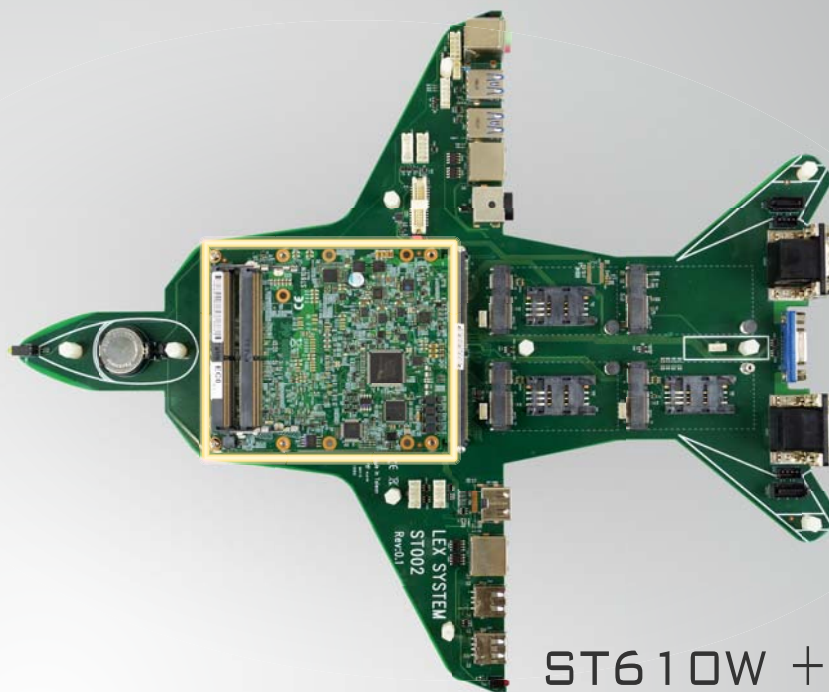

ST610W + ST002

LEX ST001 / ST002 Evaluation board

LEX ST001/ST002 evaluation board help customers evaluate the features and performance of ST610W Computer on Module. The unique appearance of ST002 proves that we can provide customized carrier board services according to customers' applications. In addition to the evaluation, design and testing purposes, ST001/ST002 helps customers to expedite their carrier board development.

Function MAP

Touch Screen
Front Panel Connector DC-Output

SATA2 SATA1 DI/O

DC-IN

PCIe+SMBus

SATA2

SATA1

DI/O

LEX SMART

mSATA+SMBUs

PCIe+SMBus

USB+SIM+SMBUs

SIM1

USB+SIM+SMBUs
LVDS

SIM2

PCIe+SMBus+LPC
PCIe+SMBus

SIM3

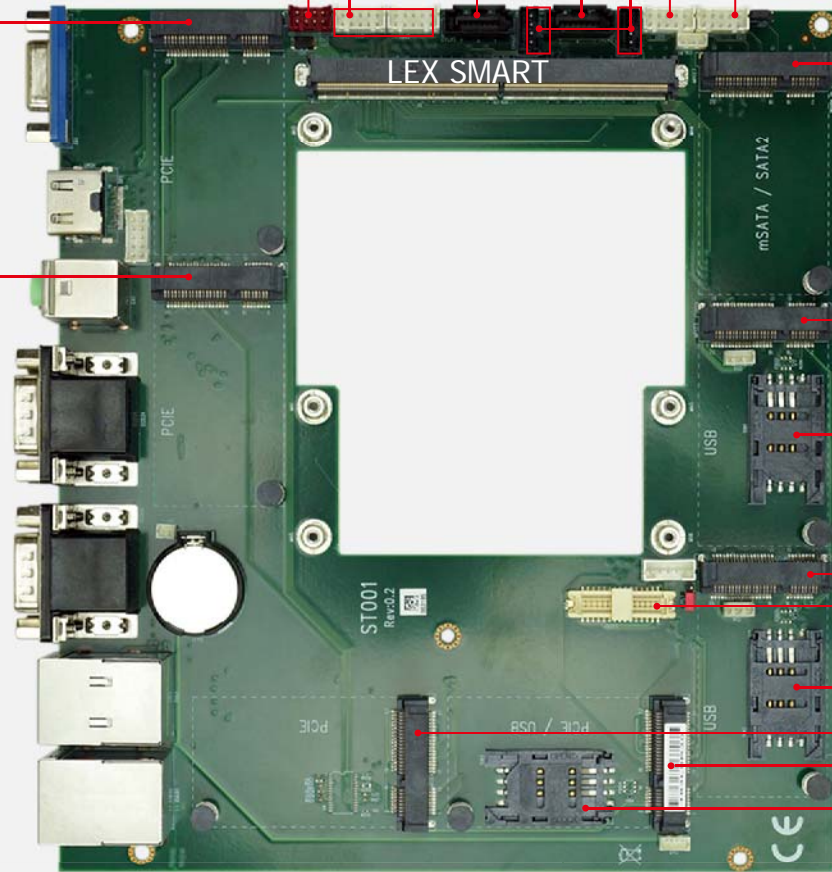

LEX ST001 Evaluation board

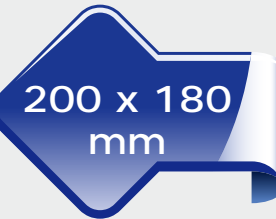

ST001

- Flexible interface for verification
- Expedite customer's evaluation board development
- 200 x 180mm form factor
- IO Interface:
 - 1 x VGA, 1 x HDMI,
 - 7 x mini PCIe, 3 x SIM holder,
 - 2 x USB 3.0, 2 x USB 2.0,
 - 4 x COM, 2 x GbE, Line-out, Mic-in



ST001 Real I / O

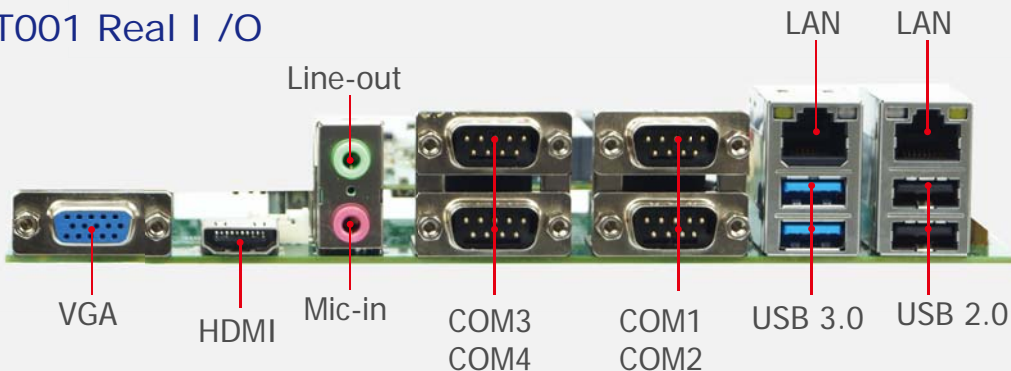

Function MAP

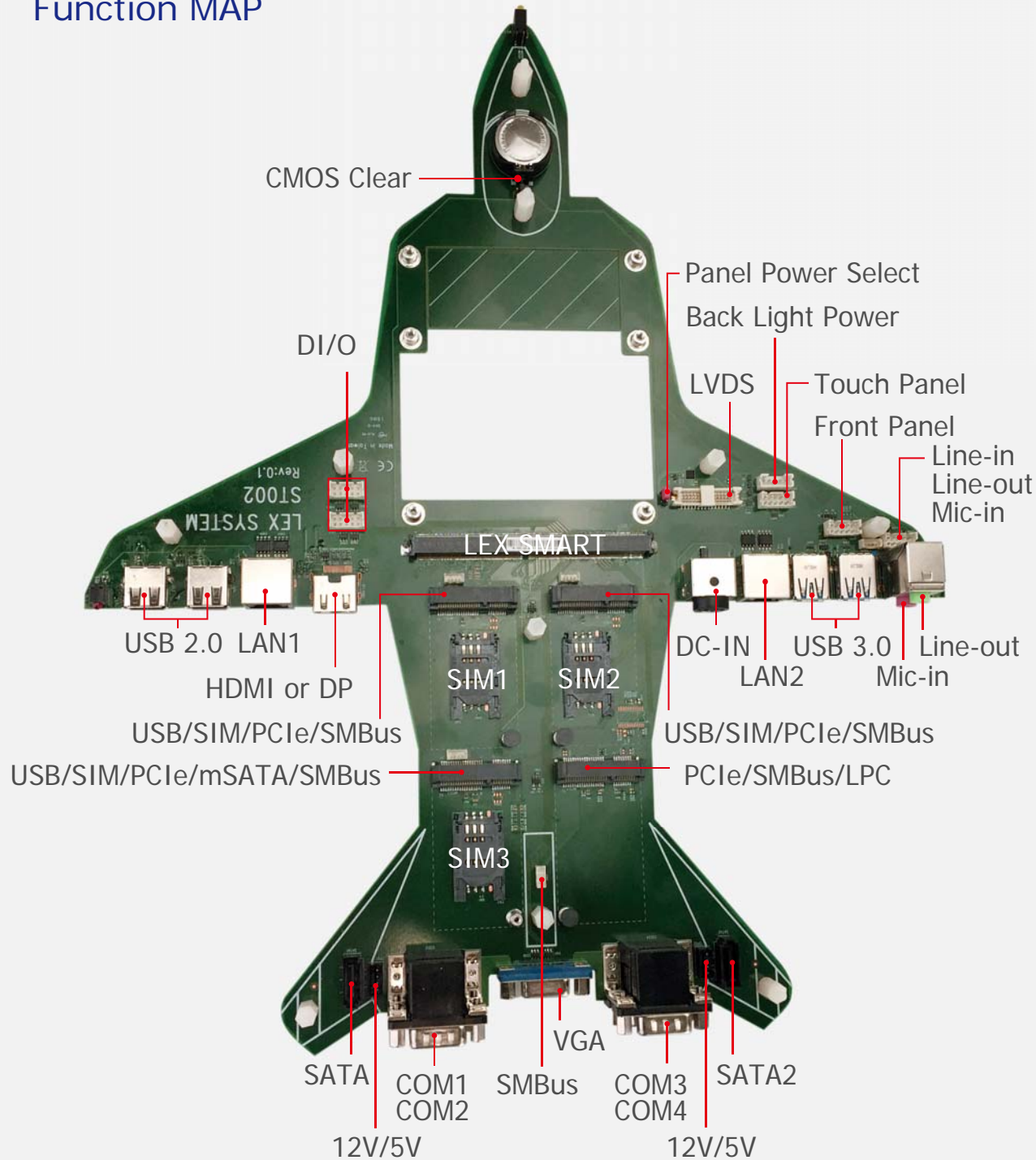

LEX ST002

Evaluation board

ST002

- Flexible interface for verification
- Expedite customer's evaluation board development

IO Interface:

- 1 x VGA, 1 x HDMI or DP,
- 4 x mini PCIe, 3 x SIM holder,
- 2 x USB 3.0, 2 x USB 2.0,
- 4 x COM, 2 x GbE, Line-out, Mic-in

